

## HPL Global Presence



**HPL INDIA LTD.**  
**HPL Electric & Power Pvt. Ltd.**  
 1/21, Asaf Ali Road, New Delhi - 110 002 Ph.: 011-23234411, 23234811  
 Fax : 011-23232639 E-mail: gsm@hplindia.com

[www.hplindia.com](http://www.hplindia.com)

*Due to continuous development, specifications and features are subject to change without prior notice.*

HPL/TAB MCCB/02-13

# SWITCH ON YOUR ELECTRICAL PROTECTION



### TAB™ : Thermal Adjustable Breaker

- TAB1 : Frame Rating 20A to 160A
- TAB2 : Frame Rating 63A to 250A
- TAB3 : Frame Rating 250A to 630A



**The Power of Technology**



# The TAB™ Series CONTENTS

Salient features

3

Application

4

Advantages

4

Working principle

5

Technology

6

Overview

7

Accessories

8

Product References & Ordering

9

Specifications

10

Characteristic curves

13



## Salient Features The TAB™ Series

- Conforms to IS / IEC 60947- 2
- Available in various frame sizes rated current from 20A-630A
- Wide range of breaking capacity available from 10kA to 65kA
- Quick-make, Quick-Break & Trip Free mechanism.
- Clear indication of 'ON', 'OFF' and 'TRIP' position.
- Low let-through energy.
- Adjustable Thermal release offers close protection from changing load.
- Line load reversibility available
- ROHS Compliant.
- Wide range of internal and external accessories.
- Uniform Door cut-out in line with MCB upto Size TAB 2
- Uniform depth of MCCB upto Size TAB 2





MCCB is suitable for circuit protection in individual enclosures, switch board, lighting and power panels as well as motor control centers.

MCCB is assigned to protect systems against overload and short circuit up to 65KA with full range of accessories.

TAB™.....series provides the following applications :-

Distribution feeder protection	Suited for incoming and outgoing feeders
Transformer protection	Effective protection to distribution transformers as outgoing breakers.
DG set protection	Used for protection and control of diesel generating sets against overloads and short circuits.
Motor protection	MCCB provides motor back up protection, provide type -2 co-ordination (as per IEC 60947) in conjunction with suitably rated contactors and relays.
Capacitor protection	Used to protect capacitors.
Protection for semi-conductor fuses	Used to protect semiconductor fuses.
UPS protection	Used for UPS and electronic equipment protection.
DC load protection	Suitable for both AC as well as DC application for protecting rectifier panel.

## Advantages

### 1. Compactness :

It is very compact in size and hence helps in saving space in the enclosures, panels etc. Due to its slim size it uses the distribution space very efficiently regardless of fact whether it is in residential or functional buildings.

### 2. Simplicity :

Its handling is easy and simple. Its simplicity and ease in use allows the user for quick installation.

### 3. Safe to use :

It is very safe to use. It protects people, installation and power supply distribution system. The insulation property of the material used is highly reliable and remains intact in even critical conditions.

### Evolution

To reflect a variety of uses and applications, the line up has been expanded up to 65 KA with high specifications. As consumption of power is increasing, circuit breaker demands for a new level of functionality, flexibility, power and space saving has become imminent.

HPL has got its very new TAB™...series of MCCBs which has improved performance and safety.

It conforms to the latest IS & IEC standards.

$I_{cs} = 100\% I_{cu}$

The IS/IEC 60947-2 specifies the  $I_{cu}$  (rated ultimate short circuit) and  $I_{cs}$  (rated service short circuit) breaking capacities to the following types:-

$I_{cu} = O-CO$

$I_{cs} = O-CO-CO$

The rise in temperature on the terminals, body etc. after the S.C. breaking capacity test is well within limits to give better life to the product and also safeguards the entire distribution system.

### Insulation

Operating Knob/Dolly is made of Thermoplastic insulating material to make it safer & reliable.

### Utilization Category

Utilization category for a circuit breaker shall be stated with reference to whether or not it is specifically intended for selectivity by means of an intentional time delay (with respect to other circuit breaker in series). Utilization category is a regulation on application with respect to selectivity.

#### 1. Utilization Category "A" :

Circuit breaker not specifically intended for selectivity under short circuit conditions. Such breakers do not have a short time withstand current rating. All Thermal-Magnetic breakers satisfy utilization category "A".

#### 2. Utilization Category "B" :

Circuit breaker specifically intended for selectivity under short circuit conditions. Such breakers have a short time withstand current rating. All electronic-type breakers satisfy utilization category "B".

## Working Principle

TAB™.....Series breakers work on current limiting principle.

Current limiting capacity of a circuit breaker is its aptitude to limit short-circuit current. When a short circuit occurs, the breaker is able to limit and lower the  $I^2t$  energy release in very short time so as to protect circuits and switchgear at downstream. This is achieved by

- Intelligent design of Arc Chamber
- Guiding the arc rapidly away from the contacts in the arc chamber.
- Quick opening of main contacts.
- Quick quenching of arc by using effective arc quenching methods & materials.

Therefore  $I_{pk}$  is limited to  $I_c$  which leads to substantial reduction in electrodynamic stresses in the system. Also  $I^2t$  let through proportional to the shaded area is considerably reduced, resulting in lower thermal stresses in downstream equipment and connecting cables.

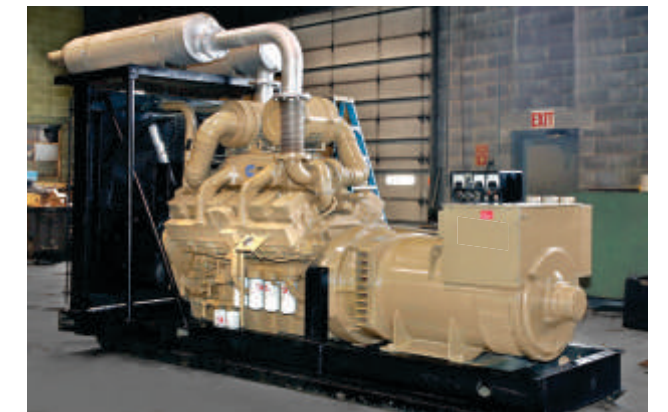
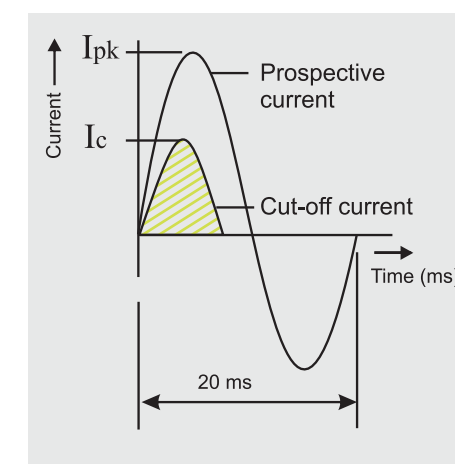





## Operating Conditions

1. Temperature : MCCBs are calibrated at 40°C as reference ambient Temperature. However with increase in ambient, compensation factor to be taken into consideration.
2. Altitude : It should be less than 2000m.
3. Pollution Degree : 3

## Isolation Function

These MCCBs are suitable for isolation also. As defined in IS / IEC 60947 - 2, the operation of isolation function highlights the following points:-

Contacts operation correctly indicates operating reliability of interior mechanism.

No residual current.

Higher impulse withstand voltage for terminals at the power supply side and load side.

## Line-load Reversibility

MCCBs have no bias of line & load connection. The power supply can be connected from either top or bottom which has no effect on normal operation of the breaker.

## The Technology For MCCB Devices

### 1. Arc Chamber

The MCCB arc chamber is specially designed with an arc channel as a flow guide to improve the capability of extinguishing the arc and reducing the arc distance.

### 2. MCCB Base And Cover

Cover and Base moulding are made of superior quality of Thermoplastics to with stand the stringent short circuit conditions with very high insulation strength to avoid any damage to the product. Covers are secured on Base mouldings with mounting screws tightened into threaded inserts in the MCCB base to have better strength.

### 3. Fixed Contact

The MCCB fixed contact does not have any mounting screws near the contact points. A steel screw can generate heat and the magnetic flux surrounding the conductor carrying the current can create a very high temperature. If a short-circuit occurs, it will cause the contact points to be welded or melted.

### 4. Thermal Magnetic Tripping

1. In case of Thermal overload, time-delay operation occurs when an over current heats and warps the bimetal to actuate the trip bar. (See-'A')

2. In case of Magnetic tripping, when high current passes through, the magnetization of the fix core enables it to attract the armature fixed on trip bar thereby tripping the breaker. (See-'B')

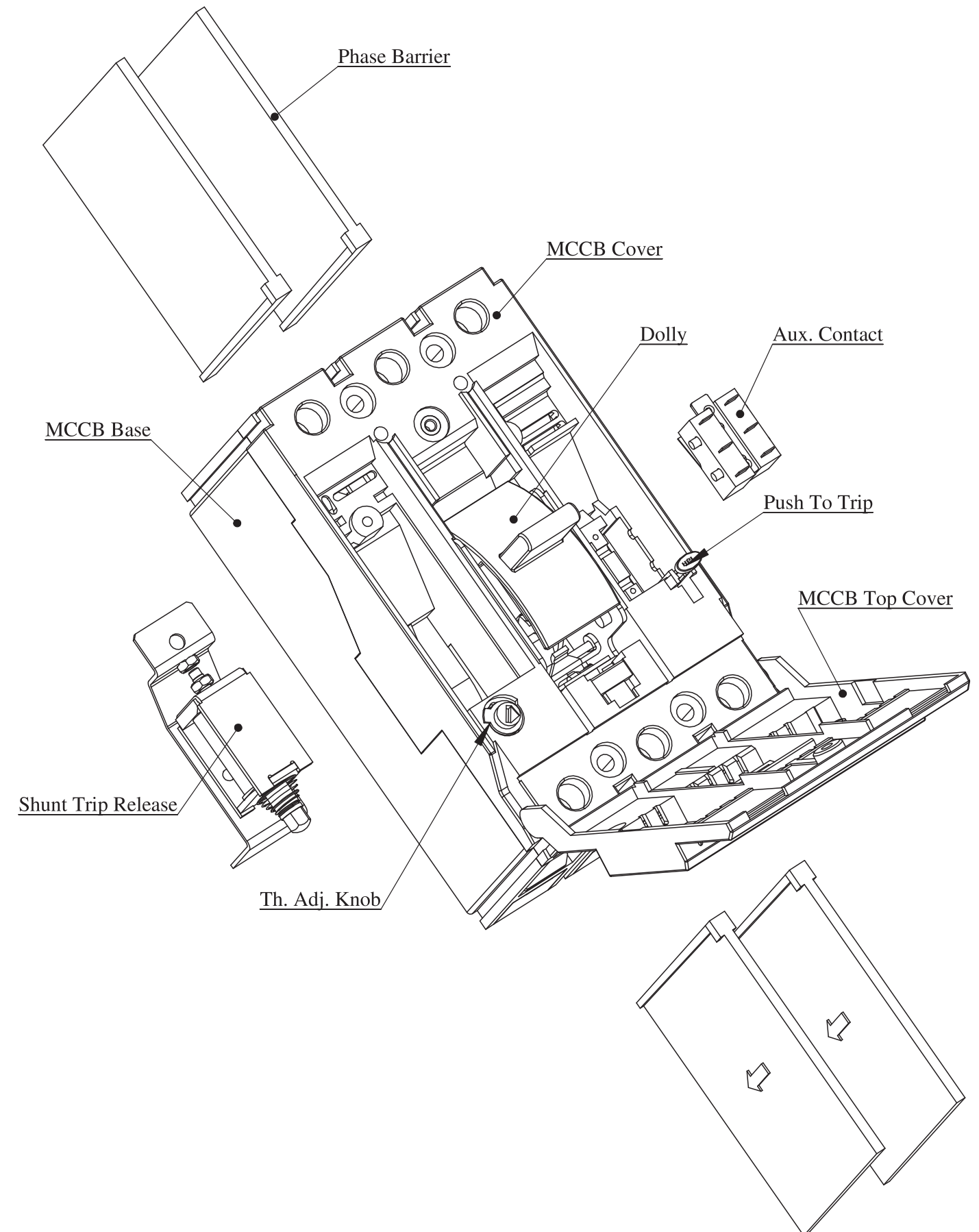
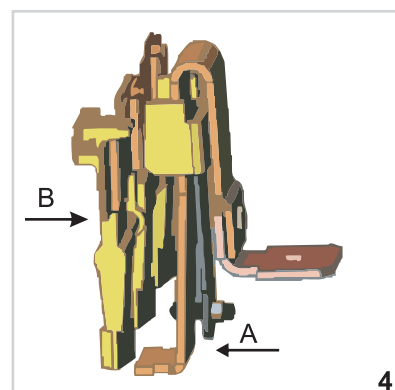
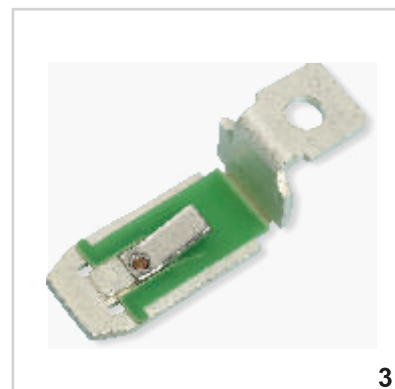
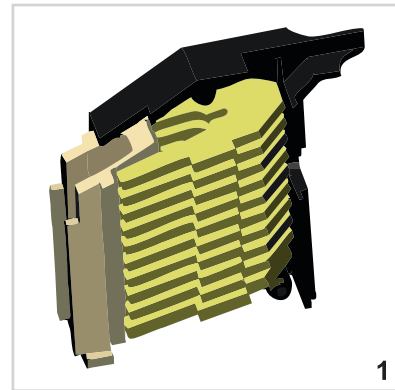



It has a wide range of accessories giving convenience and additional protection. They are of two types.

1. Internal accessory
2. External accessory.

**Internal Accessories:**

**Shunt Trip Coil**

It is a release energized by a source of voltage which may be independent of the voltage of the main circuit. It provides remote tripping of the circuit breaker. Once the MCCB trips it prevents burning of coil even if supply is continuous to coil. Its operating voltage is 70% to 110 % of rated voltage.

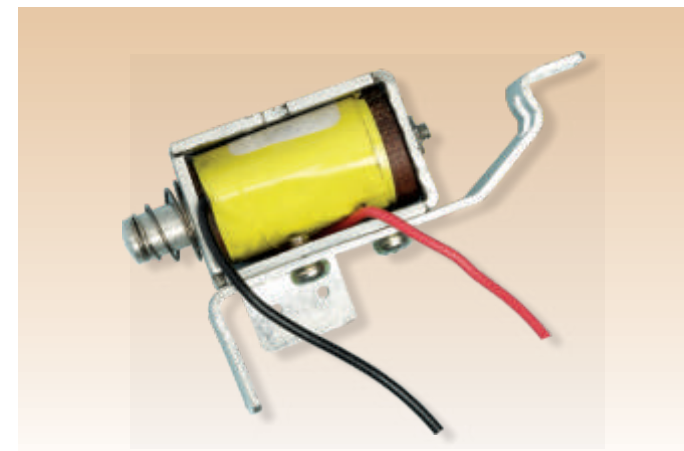

**Undervoltage Release**

It permits a mechanical switching device to open or close, with or without time delay, when voltage across release falls below a predetermined value. The normal working range is 35- 70% of the rated voltage.

**Auxiliary Switch**

It is used for remote signaling and control purposes. It consists of one or more than one potential free change over contact and acts as an indicator whether the circuit breaker's status is open or closed.



**Alarm Switch**

It is an auxiliary switch which operates only upon the tripping of the circuit breaker. It gives tripping indication once the MCCB trips.

**External Accessories:**

**Rotary Handle**

It is a toggle handle operating mechanism which serves as switching position indicator ON, OFF, TRIP. Basically it is used with breaker which is installed in an enclosure that does not allow ready access to the breaker's operating handle. The handle is allowed to be locked in the OFF or ON position for safety. This feature helps to reduce the risk associated with arc related flash burns.



**Phase Barrier**

Phase barriers are provided between the phases to increase the creepage distance between them thereby reducing the risk of phase to phase shorting.

**Technical Features**

1. Standard conformity :IS/ IEC-60947-2
2. Rated operational voltage : 415V AC
3. Rated insulation voltage: 800V AC
4. Utilization category : A
5. Rated frequency: 50/60Hz.
6. Rated impulse voltage : 8kV



Frame size	Breaking Capacity	Ics = % Icu	Rated Current TAB 1	Rated Current TAB 2	Rated Current TAB 3	Current	No. of Main Poles
TAB 1	L : 10 kA	X = 100%	020	063	250	AC	2P
TAB 2	D : 16 kA	Y = 75%	025	080	320	DC	3P
TAB 3	C : 25 kA N : 36 kA S : 50 kA H : 65 kA	Z = 50%	032 040 050 063 080 100 125 160	100 125 160 200 250	400 500		4P

<b>TAB 1</b>	<b>L</b>	<b>X</b>	<b>100</b>	<b>AC</b>	<b>3P</b>
--------------	----------	----------	------------	-----------	-----------

- TAB 1 MCCB is available with breaking capacity 10 kA / 16 kA / 25 kA / 36 kA
- TAB 2 MCCB is available with breaking capacity 25 kA / 36 kA / 50 kA
- TAB 3 MCCB is available with breaking capacity 36 kA / 50 kA / 65 kA
- TAB 3 630A is available on request.

Accessories for TAB MCCB

Frame size	Shunt Release	Under Voltage Release	Auxiliary Switch	Alarm Switch	Rotary Handle
TAB 1	110 VAC	110 VAC	1 C/O	1 C/O	RHDM : Door Mounted
TAB 2	240 VAC	240 VAC	2 C/O		RHCM : Breaker Mounted
TAB 3	415 VAC 024 VDC 048 VDC	415 VAC 024 VDC 048 VDC			

- Product Reference for 240 VAC shunt release with TAB 1 is TAB160SHT240VAC
- Product Reference for 240 VAC under voltage release with TAB 1 is TAB160UVR240VAC
- Product Reference for 1 C/O Auxiliary switch with TAB 1 is TAB160AXC1
- Product Reference for 1 C/O Alarm Switch with TAB 1 is TAB160ALC1
- Product Reference for 1 C/O Alarm / Auxiliary Switch with TAB 1 is TAB16 ISI TAB160 ALAX
- Product Reference for Rotary Handle Door Mounted with TAB 1 ISI TAB 160 RHDM
- A Maximum 2 Nos. Internal Accessories can be selected for one Breaker, one on each side
- Shunt or Under voltage release is fitted on LHS.
- Auxiliary / Alarm Switch is fitted on RHS.



No. of poles	3/4 <sup>+</sup>			
	L	D	C	N
Type	20-160A	20-160A	20-160A	20-160A
Rated Current*	20-160A	20-160A	20-160A	20-160A
Rated Operational Voltage	415V			
Rated Insulation Voltage	800V			
Rated Impulse withstand voltage	8kV			
Dielectric strength	3 KV for 1 minute			
Rated Frequency	50/60 Hz			
Reference Ambient Calibration Temperature**	40°C			
Rated Ultimate S.C. Breaking Capacity (at 415 VAC, 50/60 Hz) Icu in kA	10	16	25	36
Rated Ultimate S.C. Breaking Capacity (at 230 VAC, 50/60 Hz) Icu in kA	16	25	40	50
Rated Ultimate S.C. Breaking Capacity (at 250 VDC) Icu in kA	12	18	30	40
Rated Service S.C. Breaking Capacity (at 415 VAC, 50/60 Hz) Ics in kA	100% Icu	100% Icu	75% Icu	50% Icu
Rated Service S.C. Breaking Capacity (at 230 VAC, 50/60 Hz) Ics in kA	100% Icu	100% Icu	75% Icu	50% Icu
Rated S.C. Making Capacity (at 415 VAC, 50/60 Hz) Icm in kA	17	32	52.5	75.6
Utilization Category	A			
Positive Isolation	Available			
No. of operating cycles	Mechanical-25000; Electrical-7000			
Type of Releases	Thermal - Magnetic			
Release Setting Thermal	80-100% Adjustable			
Release Setting Magnetic	Fixed			
Terminal Capacity (Cables)	50mm <sup>2</sup> max.			
Terminal Capacity (Link)	120mm <sup>2</sup> max.			
Terminal Capacity (Busbar width for direct mounting)	16 mm max.			
Size (H x B x D)	<b>Dim.</b>	<b>3P</b>	<b>4P</b>	<b>Unit</b>
	H	130	130	mm
	B	75	100	mm
	D	71	71	mm
Weight	1.2 Kg (3P) & 1.6 Kg (4P)			
Reference Standards	IS / IEC 60947-2			

Notes :- \*Continuous current rating available are 20, 25, 32, 40, 50, 63, 80, 100, 125 & 160 Amps.

\*\*However on demand, MCCBs can be provided with calibration done at higher temperature also.

4P MCCBs are available in TPN as well as true 4 pole version.

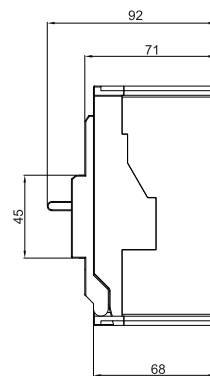
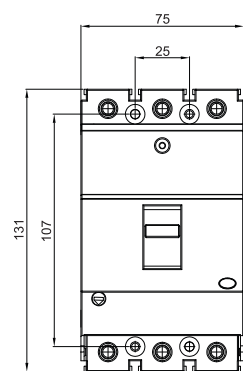

Frame 1

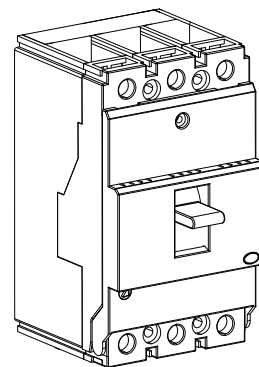

No. of poles	3/4 <sup>+</sup>			
	-	C	N	S
Type	-	C	N	S
Rated Current*	-	63-250A	63-250A	63-250A
Rated Operational Voltage	415V			
Rated Insulation Voltage	800V			
Rated Impulse withstand voltage	8kV			
Dielectric strength	3 KV for 1 minute			
Rated Frequency	50/60 Hz			
Reference Ambient Calibration Temperature**	40°C			
Rated Ultimate S.C. Breaking Capacity (at 415 VAC, 50/60 Hz) Icu in kA	-	25	36	50
Rated Ultimate S.C. Breaking Capacity (at 230 VAC, 50/60 Hz) Icu in kA	-	40	50	70
Rated Ultimate S.C. Breaking Capacity (at 250 VDC) Icu in kA	-	30	40	55
Rated Service S.C. Breaking Capacity (at 415 VAC, 50/60 Hz) Ics in kA	-	100% Icu	100% Icu	50% Icu
Rated Service S.C. Breaking Capacity (at 230 VAC, 50/60 Hz) Ics in kA	-	100% Icu	100% Icu	50% Icu
Rated S.C. Making Capacity (at 415 VAC, 50/60 Hz) Icm in kA	-	52.5	75.6	105
Utilization Category	A			
Positive Isolation	Available			
No. of operating cycles	Mechanical-20000; Electrical-5000			
Type of Releases	Thermal-Magnetic			
Release Setting Thermal	80-100% Adjustable			
Release Setting Magnetic	Fixed			
Terminal Capacity (Cables)	95mm <sup>2</sup> max.			
Terminal Capacity (Link)	185mm <sup>2</sup> max.			
Terminal Capacity (Busbar width for direct mounting)	22 mm max.			
Size (H x B x D)	<b>Dim.</b>	<b>3P</b>	<b>4P</b>	<b>Unit</b>
	H	150	150	mm
	B	105	140	mm
	D	72	72	mm
Weight	2.3 Kg (3P) & 2.9 Kg (4P)			
Reference Standards	IS / IEC 60947-2			

Notes :- \*Continuous current rating available are 63, 80, 100, 125, 160, 200 & 250 Amps.

\*\*However on demand, MCCBs can be provided with calibration done at higher temperature also.

\*4P MCCBs are available in TPN as well as true 4 pole version.

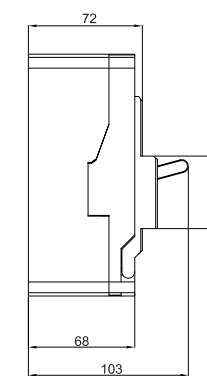
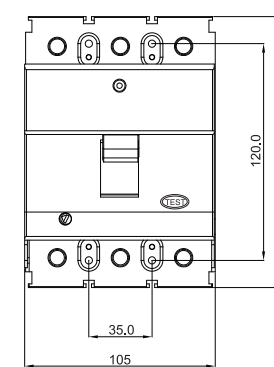

Frame 2

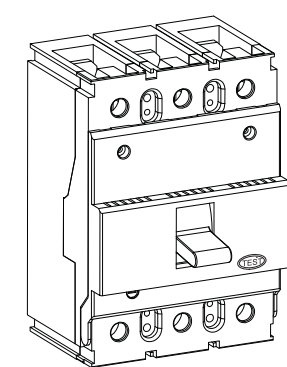





No. of poles	3/4 <sup>+</sup>				
Type	-	N	S	H	
Rated Current	-	250-630A	250-630A	250-630A	
Rated Operational Voltage	415V				
Rated Insulation Voltage	800V				
Rated Impulse withstand voltage	8kV				
Dielectric strength	3 KV for 1 minute				
Rated Frequency	50/60 Hz				
Reference Ambient Calibration Temperature*	40°C				
Rated Ultimate S.C. Breaking Capacity (at 415 VAC, 50/60 Hz) Icu in kA	-	36	50	65	
Rated Ultimate S.C. Breaking Capacity (at 230 VAC, 50/60 Hz) Icu in kA	-	65	85	95	
Rated Ultimate S.C. Breaking Capacity (at 250 VDC) Icu in kA	-	20	25	35	
Rated Service S.C. Breaking Capacity (at 415 VAC, 50/60 Hz) Ics in kA	-	100% Icu	75% Icu	50% Icu	
Rated Service S.C. Breaking Capacity (at 230 VAC, 50/60 Hz) Ics in kA	-	100% Icu	75% Icu	50% Icu	
Rated S.C. Making Capacity (at 415 VAC, 50/60 Hz) Icm in kA	-	76	105	143	
Utilization Category	A				
Positive Isolation	Available				
No. of operating cycles	Mechanical-15000; Electrical-3000				
Type of Releases	Thermal-Magnetic				
Thermal Release Setting	Adjustable 70-100%				
Magnetic Release Setting	Adjustable 6In - 10In				
Terminal Capacity (Cable)	-				
Terminal Capacity (Link)	320mm <sup>2</sup> max.				
Terminal Capacity (Busbar width for direct mounting)	28 mm max.				
Size (H x B x D)		<b>Dim.</b>	<b>3P</b>	<b>4P</b>	<b>Unit</b>
		H	254.5	254.5	mm
		B	140	184	mm
		D	99	99	mm
Weight	6.8 Kg (3P) & 8.8 Kg (4P)				
Reference Standards	IS/IEC 60947-2				

Notes :- \*However on demand, MCCBs can be provided with calibration done at higher temperature also.

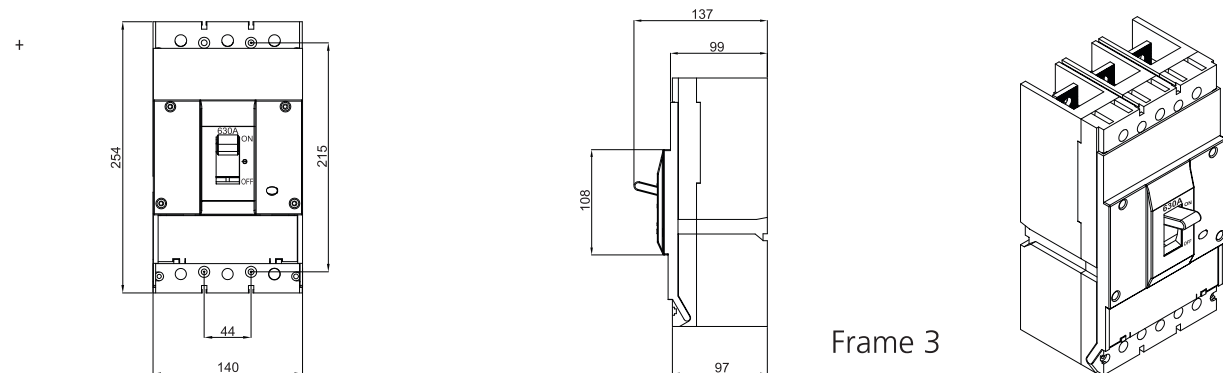

Frame 3

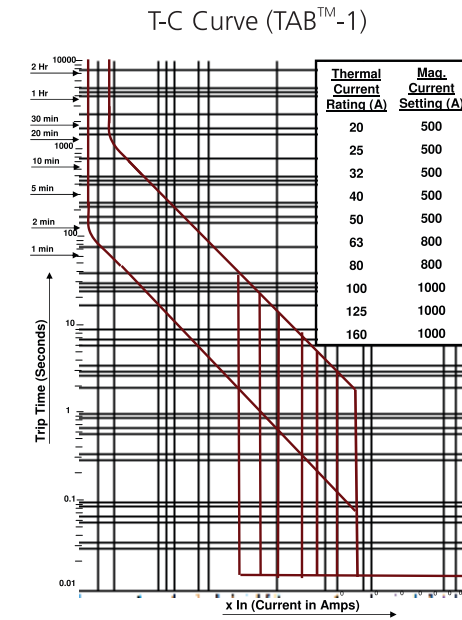

Ambient Compensation Curve(TAB-1)

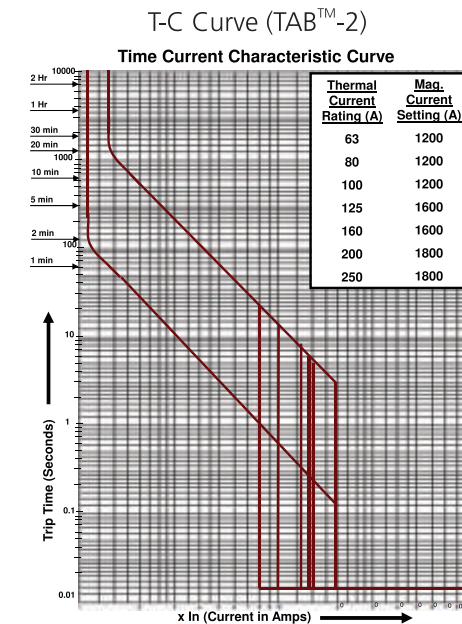
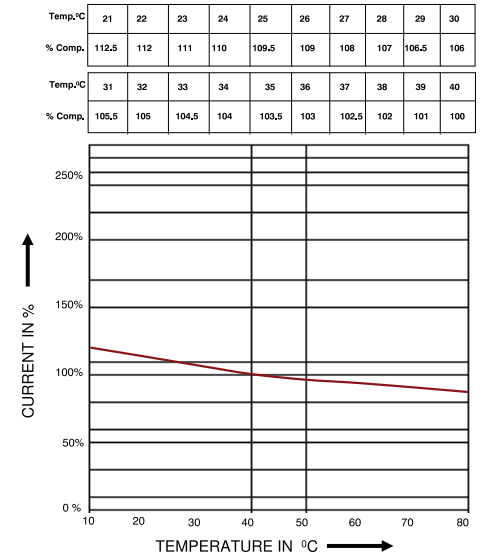

Ambient Compensation Curve (TAB-2)

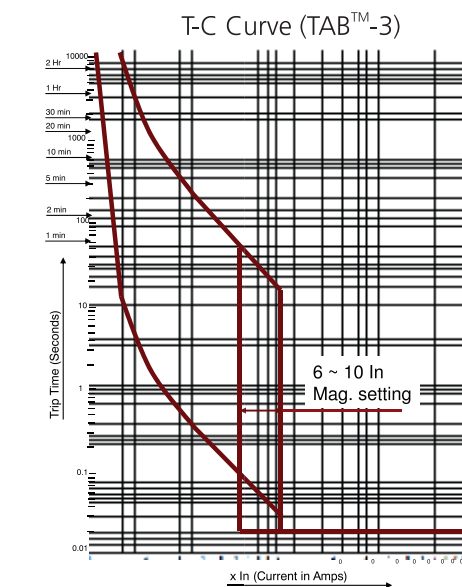
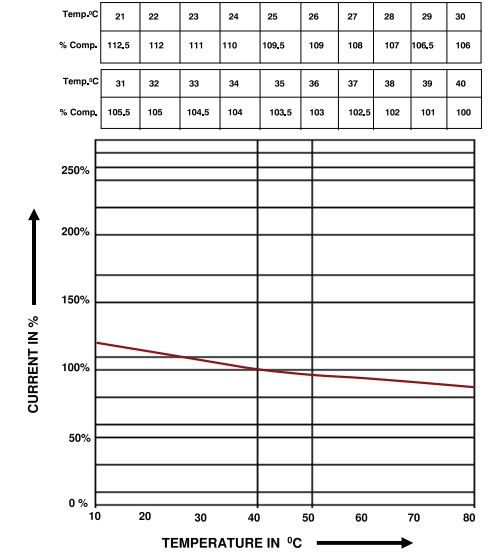

Ambient Compensation Curve (TAB-3)

